

Wide range of switches, energy sockets (compliant with national and international standards), data sockets, devices for the management of climate control, comfort, technical alarms signalling, emergency lighting. The Chorus modular devices are available in four colors, glossy white, satin black, painted titanium and glossy ivory and in different modularities, 1/2, 1, 2 and 3 modules. Thanks to the frame supports for rectangular, square and round boxes, the devices allow you to create endless combinations with the range of Chorus plates.

Category	Socket-outlet	Description	2P+E - 10A
Colour	Black	Voltage	250 V ac
Standard	Australian	For plug pins	Flat
Wiring terminals	With screw	Standard	IEC 60884-1; AS/NZS 3112
Resistance at test voltage	2000 V a 50 Hz for 1 minut	Insulation resistance	> 5 MOhm
Breaking capacity	1.25 In (100 position changes)	Prolonged operation (no.of position changes)	10.000 at In 250 V ac cosØ=0,8
Thermo-pressure with ball	125 °C	Glow Wire Test	850 °C
Terminal grip on cable traction	> 50 N	Terminal tightening capacity flexible cables (mm2)	min. 0,75 - max. 2x4
Terminal tightening capacity rigid cables (mm2)	min. 0,5 - max. 2x2,5	No. Chorus modules	2
Electrocod	0131		

DIMENSIONAL

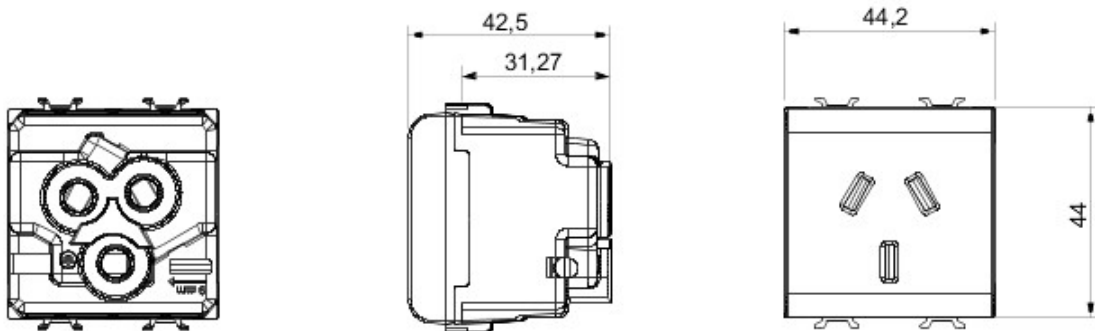

TECHNICAL SYMBOLOGY



EN 60695-10-2

125 °C



850 °C

STANDARDS/APPROVALS

App. No.
ESV170478

GEWISS S.p.A. Via A. Volta, 1
24069 Cenate Sotto - Bergamo - Italy
tel. +39 035 94 61 11 fax +39 035 94 69 09

www.gewiss.com
sat@gewiss.com
Last update 10/07/2018

Data, measures, designs and pictures are shown only as informativ purposes, and could be changed without previous notice