

1

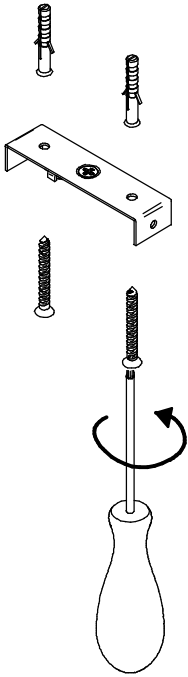

- Fissare la staffa sul soffitto
- Have the backplate fixed on the ceiling
- Fixer l'etrier sur le plafond
- Den stegbuegel an die decke befestigen
- Fijar el estribo al techo

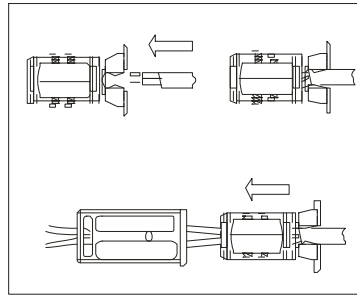

- Cablaggio articolo
- Wiring
- Electrification
- Verkabelung
- Cablaje articulo

2

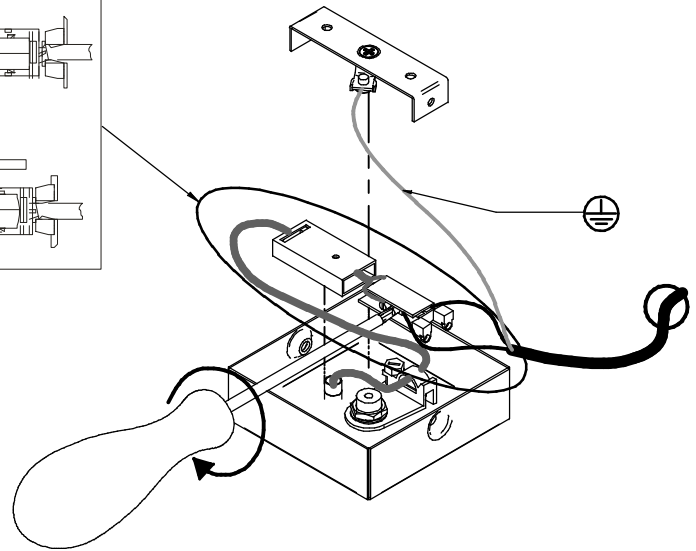

3

- Montaggio a muro
- Fix on a wall
- Montage au mur
- Deckeneinbau
- Montaje de pared

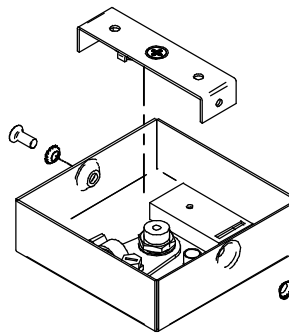

4

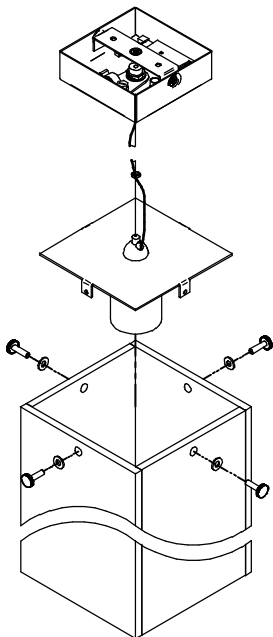

- Montaggio del vetro
- Fix the glass
- Montage du verre
- Glaseinbau
- Montaje cristal

5

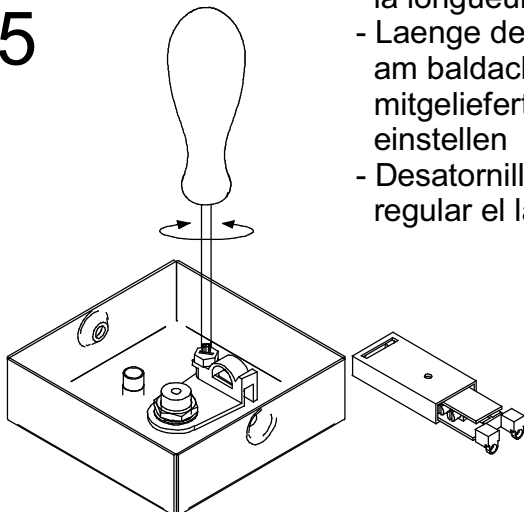

- Svitare il grano e regolare la lunghezza dei cavi
- Release the side screw to have the wire adjusted
- Devisser l'ecrou et regler la longueur des cables
- Laenge der stromkabel am baldachin mit mitgeliefertem schlussel einstellen
- Desatornillar la tuercay regular el largo de los cables

6

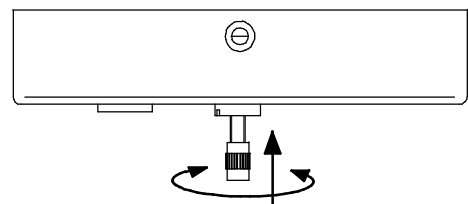

- Per regolare il cavo d'acciaio svitare la bocchetta e premere sul perno
- To adjust the stainless steel cord unscrew the metal part while pressing the pin
- Pour regler le cable d'acier devisser lembout et appuyer sur le pivot
- Laenge der haltseile einstellen huelse herausdrehenlaenge einstellen und wieder befestigen
- Para regular el cable de acero desatornillar el casquillo y apretar el perno