



Product code	Color
256-200AN-21	Mat white

General Specifications

Product type	: Downlights
Mounting type	: Ceiling - recessed
Description	: Adjustable downlight for diffused lighting designed for the last generation of COB LEDs, with a shallow depth. LED drivers should be ordered separately, the wattage of the fittings changes depending on the selected driver. Protection rating IP20. Low glare levels UGR < 19 (Unified Glare Rating).
Indoor/outdoor lights	: Indoor
Applications	: Offices, Retail , Shopping centres

Lighting specifications

Average lamp life (h)	: L80B10 50.000
Lamp description	: LED 2900lm 21W 4000K
Nominal lumens on thermal regime	: 2900
Efficiency L.O.R. (%)	: 89,0
Delivered lumens (lm)	: 2581
Lamp wattage (W)	: 21
Color temperature (K)	: 4000

Physical Specifications

Body	: Die-cast aluminium
Finishes	: Polyester painted
Reflector	: Mirror-metallized thermoplastic material
Closing Screen	: Clear polycarbonate
Thermal Dissipation	: Passive
Ring	: Die-cast aluminium

Electrical Specifications

Glow wire (°C)	: 850
Driver	: Separate item
Driver mounting	: Remote

Weight and Dimensions

Shape	: Round
External diameter (mm)	: 125
False ceiling thickness (mm)	: 1-30
Height (mm)	: 79
Cutout shape	: Round
Cutout Diameter (mm)	: 116
Recessed depth (mm)	: 79
Weight (Kg)	: 0.7

Optical Specifications

Aiming	: Adjustable
Light distribution	: Symmetric
Light emission	: Direct
Light beam	: 55°
Horizontal orientation	: +/- 20°
Note	: 18°, 30° (mirror metallized), 70° (white) optics are available on demand.
Unified Glare Rating (U.G.R.)	: <19

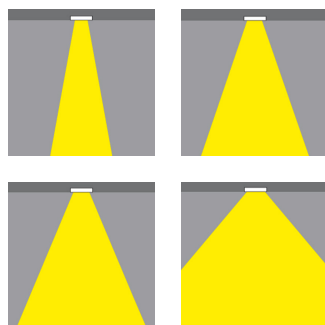
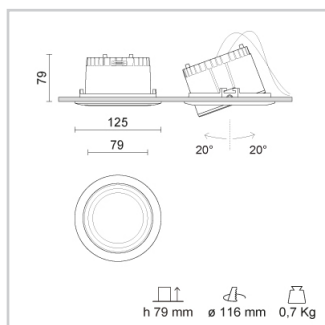

ACCESSORIES



Product Code : 28-3142-51
 Name : Professional optic device 30°
 Finish : Mirror metallized
 Shape : Round



Product Code : 28-3141-31
 Name : Professional optic device 70°
 Finish : White
 Shape : Round



Product Code : 28-3140-51
 Name : Professional optic device 18° (included diffuser)
 Finish : Mirror metallized
 Shape : Round

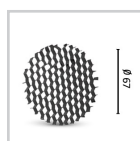

Product Code : 28-4019-30
 Name : Honeycomb
 Finish : Black painted
 Shape : Round

Drivers

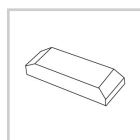

Product Code : 81-04022
 Name : Driver 600mA
 description : Driver 600mA.

Lamps	Lamp categories	Lamp type	Lamp wattage (W)	Nominal lumens on thermal regime (lm)	Color rendering (CRI)
-------	-----------------	-----------	------------------	---------------------------------------	-----------------------



LED



COB LED

21

2900

85

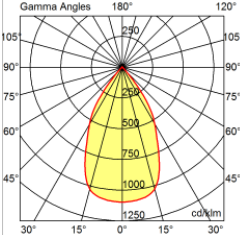
Photometrics

255-2 / 256-2	RA 11 DIXIT LED 21W 2900lm 4000K				R:100%				I.Max:1096 Cd/Klm					
Gamma Angles	H[m]	D[m]	Max lux	Med lux	Alpha=58°	H[m]	D[m]	Max lux	Med lux	Beta=58°	H[m]	D[m]	Max lux	Med lux
	1.00	1.13	2829	1532		1.00	1.13	2829	1532		1.00	1.13	2829	1532
	2.00	2.26	707	383		2.00	2.26	707	383		2.00	2.26	707	383
	3.00	3.38	314	170		3.00	3.38	314	170		3.00	3.38	314	170
	4.00	4.51	177	96		4.00	4.51	177	96		4.00	4.51	177	96
	5.00	5.64	113	61		5.00	5.64	113	61		5.00	5.64	113	61

Pictures and Applications

