



Product code	Colour
738-016-21	Mat white
738-016-16	Black
738-016-52	Silver, on demand

General Specifications

Product type	: Spotlights
Mounting type	: LKM 3-phase track
Description	: For 3-phase tracks LKM
Indoor/outdoor lights	: Indoor
Applications	: Display areas, Shop windows, Shops

Lighting specifications

Lamp description	: IPAR30 max 100W E27
------------------	-----------------------

Physical Specifications

Body	: Die-cast aluminium
Finishes	: Polyester painted
Ring	: Die-cast aluminium

Electrical Specifications

Glow wire (°C)	: 850
Voltage (V)	: 250
Frequency (Hz)	: 50/60



Weight and Dimensions

Height (mm)	: 173
Weight (Kg)	: 0.5



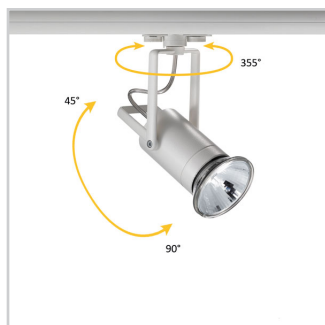
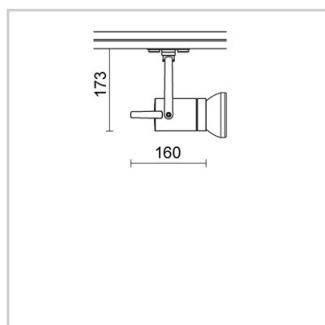





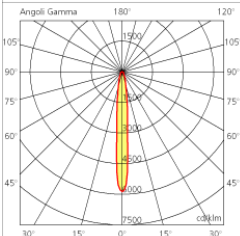

Optical Specifications

Aiming	: Adjustable
Light distribution	: Symmetric
Light emission	: Direct
Horizontal orientation	: 355°
Vertical tilt	: 45° upwards and 90° downwards



Lamps	Lamp categories	Lamp type	Lamp wattage (W)	Base	Nominal lumens on thermal regime (lm)	Color rendering (CRI)
	Halogen	IPAR30	75	E27	6500	100
	Halogen	IPAR30	100	E27		

Photometrics

738-0	DRIM IPAR30 75W E27				R:100%				I.Max:5863 Cd/Klm					
Angoli Gamma	H[m]	D[m]	Max Lux	Med Lux	Alpha = 10°	H[m]	D[m]	Max Lux	Med Lux	Beta = 10°	H[m]	D[m]	Max Lux	Med Lux
	1.00	0.18	6449	4342		1.00	0.18	6449	4342		1.00	0.18	6449	4342
	2.00	0.35	1612	1086		2.00	0.35	1612	1086		2.00	0.35	1612	1086
	3.00	0.53	717	482		3.00	0.53	717	482		3.00	0.53	717	482
	4.00	0.71	403	271		4.00	0.71	403	271		4.00	0.71	403	271
	5.00	0.89	258	174		5.00	0.89	258	174		5.00	0.89	258	174

Pictures and Applications

